

Mr. Giansante



Visual Basic

Flowcharts

August 2016

Flowcharts

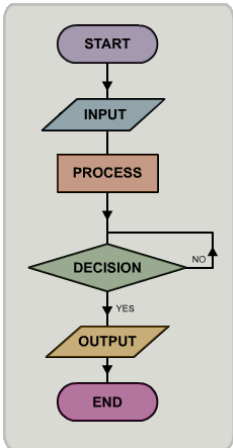

A flowchart is a planning and analysis tool.

It is a graphical representation of the steps in a work process.

In computer programming, flowcharts are used to describe each processing path in a program (the main program and various subroutines that could be branched to).

Creating Flowcharts

When creating flowcharts using pen and paper, there are templates available to trace the symbols.

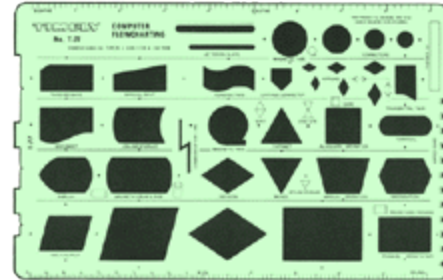

Common Flowchart Symbols

Flowchart symbols are defined by the International Organization for Standards (ISO) International Standard 1028 - "Information Processing - Flowchart Symbols"

There are dozens of flowchart symbols, the most common of which are shown below ...

Name	Symbol	Use in flowchart
Oval		Denotes the beginning or end of a program.
Flow line		Denotes the direction of logic flow in a program.
Parallelogram		Denotes either an input operation (e.g., INPUT) or an output operation (e.g., PRINT).
Rectangle		Denotes a process to be carried out (e.g., an addition).
Diamond		Denotes a decision (or branch) to be made. The program should continue along one of two routes (e.g., IF/THEN/ELSE).

Note: Dotted lines are used for comments.

There are numerous computer programs which allow users to create flowcharts.

A program that you can use to easily create flowcharts is Inspiration.

In addition, almost all word processing program support some form of flowchart creation. In Microsoft Word, show the "Drawing" toolbar. Select "AutoShapes" and then "Flowchart".

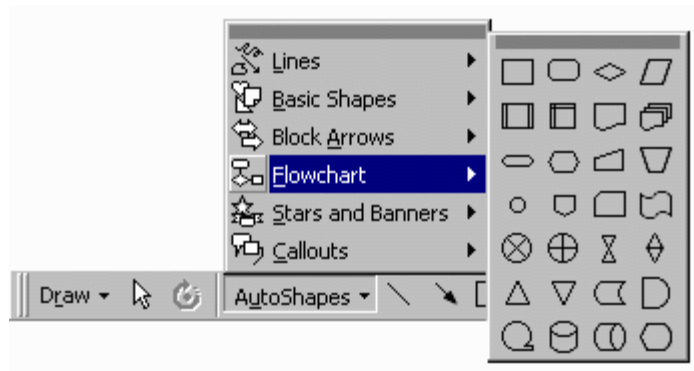

Flowchart Examples

Volume Program

The following flowchart describes a program that calculates the Volume and Surface Area of a cylinder, given the radius and height.

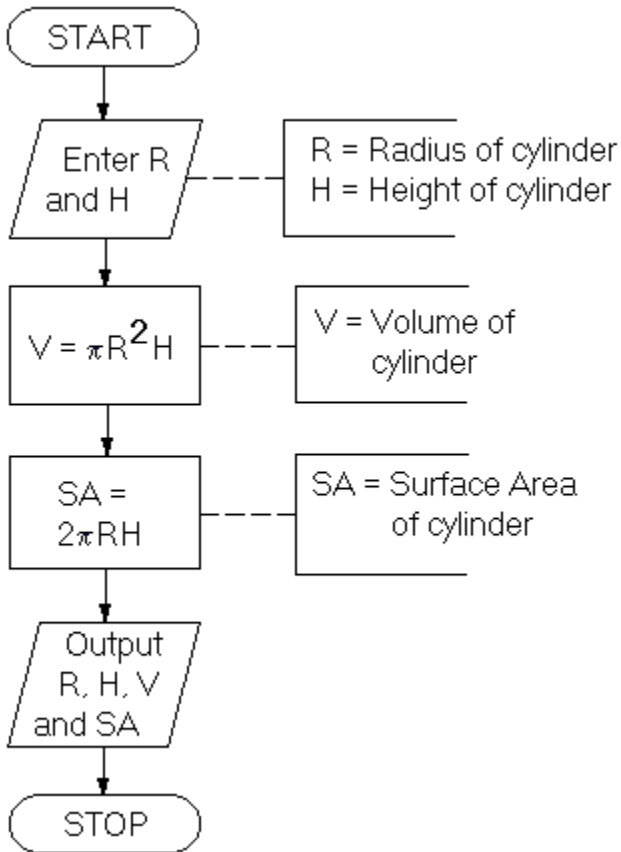

Thermostat Program

The following flowchart describes a program that controls a heater. If the temperature falls below 20°C, then the heater is turned on. If the temperature rises above 23°C, then the heater is turned off.

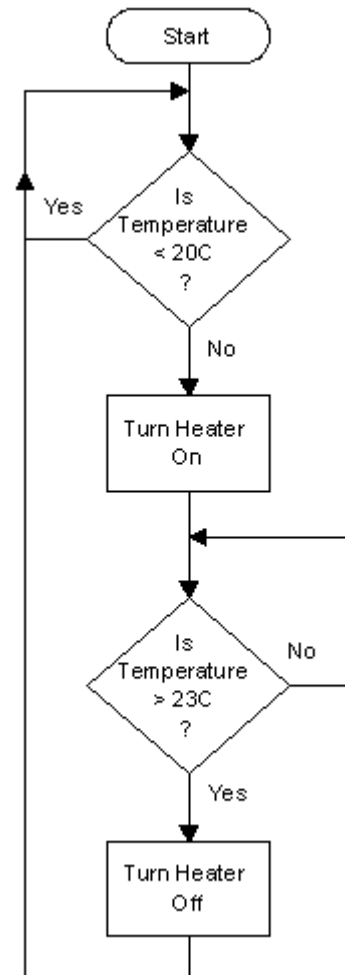

Flowchart Examples

Calculating Factorial

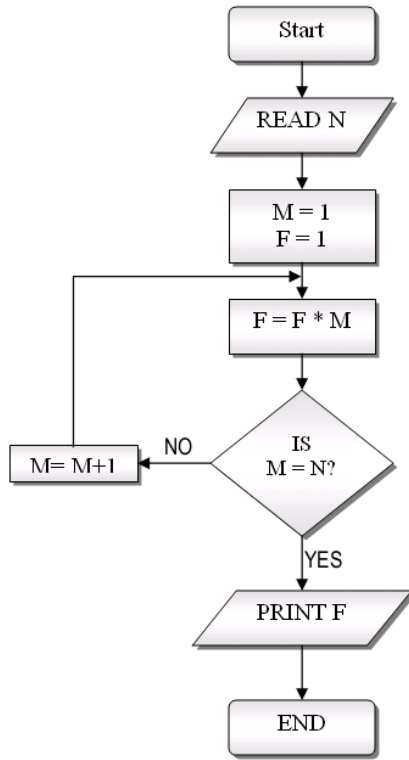

Bubble Sort

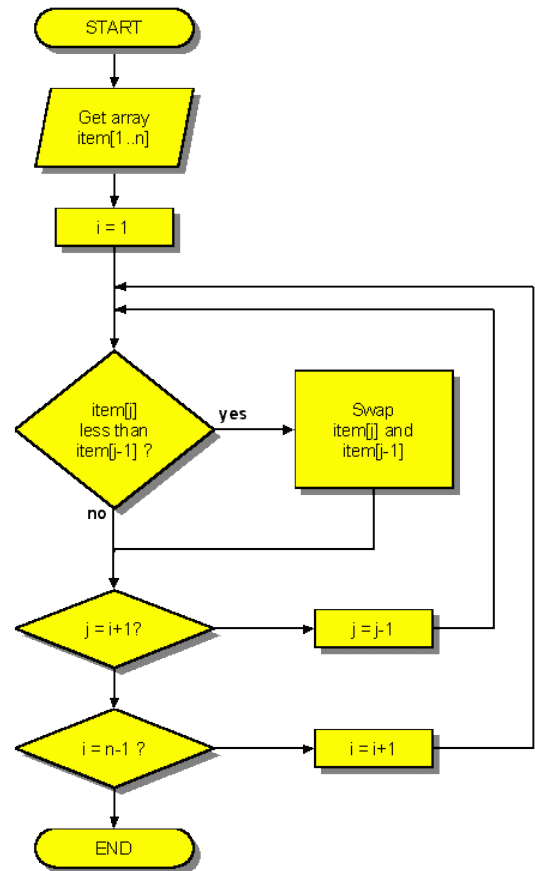

Concentration Game

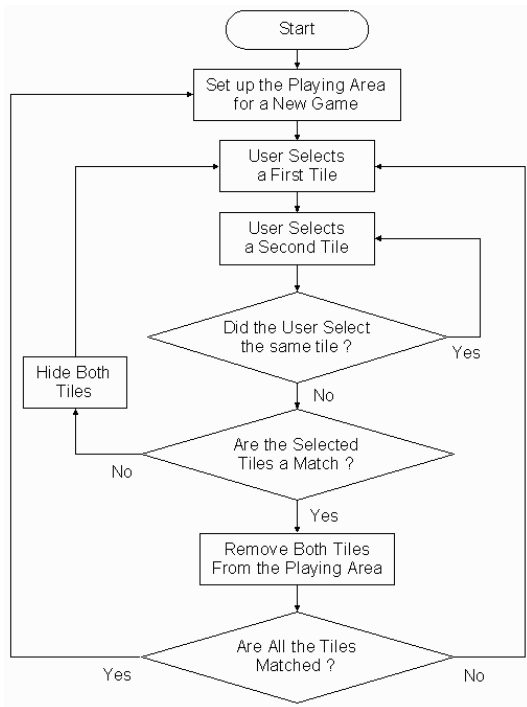

Flowchart Exercises

Name _____

Date _____

Indicate what each of the five basic flowchart symbols below represent.

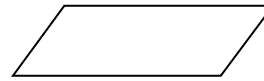
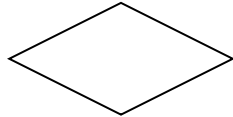
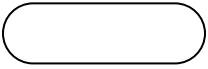

Draw a flowchart for a program that asks a user to guess a number between 1 and 10 until the user guesses correctly.